



Valiani Ultra | Optima | Omnia

Valiani Optima V50

Entry level cutting table for prototyping, packaging and short run applications.

Optima V50

The Optima V50 is an affordable cutting solution for short run cutting projects. It is the ideal solution for a company wishing to start producing mock-ups, prototypes and small production runs without the need of die cutting.

Key Features

- Single head system capable of a tool changeover in less than 10 seconds without any mechanical adjustment
- Comes with a base, a vacuum bed for easier media holding, a fold away pin system for easy-alignment and a camera for crop mark detection
- A3+ sheets or maximum sheet size 540 x 800mm

Materials

- Corrugated and folding cardboard
- PVC and foam board
- Vinyl/Plastic Adhesive sheets
- Diamond grade reflective sheets
- Leather, fabric and foam

VersaTool -

Type Interchangeable Heads

Tool Holder enables the use of all the interchangeable heads series. The main applications are Kiss-cut, bevel cut on chip boards and varnishing blankets cut. Cutting option available 40°, 45°, 90° and Embossing.



Cutting Head

Precise Multi depth cutting tool for material up to 5 mm (3/16") thick.



Optima V50

Working area	540mm x 800mm
Width	1440mm
Depth	1180mm
Height	1200mm
Weight	280kg
Max Speed	500mm/sec
Main Supply	Single Phase 220 50Hz - 10A
Pneumatics	6 Bar/90 PSI 8 Bar/115 PSI (5.3 CFM) with oscillating tool head
Connectivity	USB
Data Buffer	External PC (Not included)
Tool Change	Manual

Creasing Tool

Complete Creasing Tool with 9 wheels to crease and perforate folding cardboard and corrugated cardboard.



Plotting Tool

Plotting Tool to create dynamic drawing or text on the cardboard patterns.



Pneumatic Oscillating Cutting Tool

Powerful pneumatic vibrating tool for cutting various strengths of materials up to 20 mm.



Valiani Optima V80 | 160 | 250

Valiani cutting tables offer refined **cutting technology** that can satisfy the most **demanding** users.

Optima V Series

The Optima series of digital cutting machines provides the user with a large range of finishing processes such as cutting and creasing, which meets the requirement of many markets and applications in the offset/digital printing industry, display and packaging market, apparel and leather industry. It's the ideal solution for short/medium runs of die cutting textile/cardboard patterns, prototyping, furnishing creation, and much more. Precision, reliability and flexibility are the key features. Simple and intuitive to use, the Optima series incorporates refined cutting technology that can satisfy the most demanding users.

Key Features

- Manual cutting depth adjustment from 0.1mm to 20mm (with optional oscillating blade)
- Vacuum table for holding media in place.
- Twin head tool station
- Interchangeable creasing accessories for creasing / perforating a wide range of media.
- Crop mark detection as standard

Optima V cutting sizes

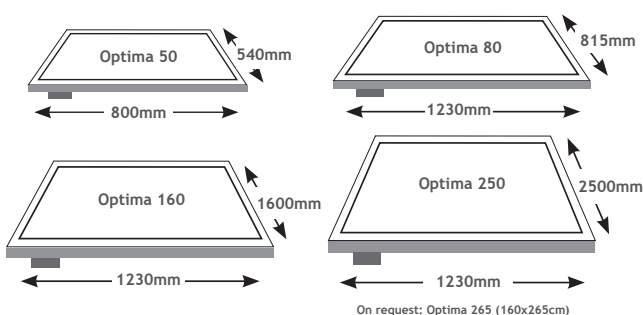

Optima 80



Optima 160

Twin head tool station

With two configurable tool stations, the Optima V is a medium-format professional cutting plotter capable of cutting, half cutting and creasing, drawing and oscillating, cutting up to 20mm thickness.



Valiani Optima V80 | 160 | 250

OptiCrop camera

The Optima V comes as standard with a camera for crop mark detection. This device, used in combination with optional software OptiCrop, can perform accurate contour cutting and creasing around preprinted media even with print-distorted materials.

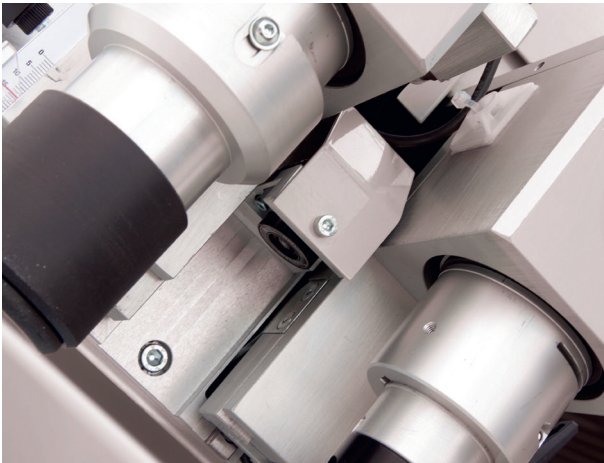

VersaTool

Now all Ultra V magnetic heads are compatible with the Optima 'twin head station' with the addition of the new 'VersaTool'. This combines the range and versatility of the ultra V series tools, with the speed and efficiency of the Optima range.



- Blue 45° Bevel Cut (rear)
- Red 45° Bevel Cut (front)
- Yellow 90° Straight Cut (multi material)
- Purple Debossing
- White 90° Straight Cut
- Green 40° Bevel Cut (front)
- Grey 90° Straight Cut

Optima 80

Working area	1230mm x 815mm
Width	1830mm
Depth	1430mm
Height	1200mm
Weight	440kg
Max Speed	840mm/sec
Main Supply	Single Phase 220 50Hz - 10A
Pneumatics	6 Bar/90 PSI 8 Bar/115 PSI (5.3 CFM) with oscillating tool head
Connectivity	USB
Data Buffer	External PC (Not included)
Tool Change	Manual

Optima 160

Working area	1230 x 1600mm
Width	1830mm
Depth	2230mm
Height	1200mm
Weight	490kg
Max Speed	430mm/sec
Main Supply	SP 200/208V 50/60Hz - 16A
Pneumatics	6 Bar/90 PSI
Connectivity	USB
Data Buffer External	PC (Not included)
Tool Change	Manual
Media Holding System	Pneumatic

Optima 250

Working area	1230 x 2500mm
Width	1830mm
Depth	3010mm
Height	1200mm
Weight	600kg
Max Speed	430mm/sec
Main Supply	SP / 110V60Hz/10S, 220V/50Hz/10A
Pneumatics	6 Bar/90 PSI
Connectivity	USB
Data Buffer External	PC (Not included)
Tool	Change manual
Media Holding System	Pneumatic

Flexible and efficient.

The perfect solution for **prototyping** and **packaging**, cuts material up to **5mm thick**.

Ultra V

The Ultra V series, is available in 2 table sizes. The Ultra 120 with a cutting area of 1215 x 815mm and the Ultra 150 with a cutting area of 1515 x 1015mm. These machines offer an efficient, flexible, versatile, solution for prototyping and short run packaging, as it can cut material up to 5mm thick.



Ultra V

Key Features

- Manual cutting depth adjustment from 0.1mm to 5mm
- Vacuum table for holding media in place.
- Fast magnetic tool change
- Interchangeable creasing accessories for creasing / perfering a wide range of media.
- Optional crop mark detection

Applications

- Die-Cutting of Digital & Offset Prints
- Box and Packaging Production
- POP/POS Display
- Street and Business Signage
- Offset Varnishing Plates
- Architectural and plastic models
- Decals and stickers
- Cardboard Honeycomb Furniture

Vacuum table efficiency

The large vacuum table workspace, combined with a new clamping system ensures effective reduction of media displacement. This means you no longer have to worry about material being held in place regardless of thickness, weight or texture.

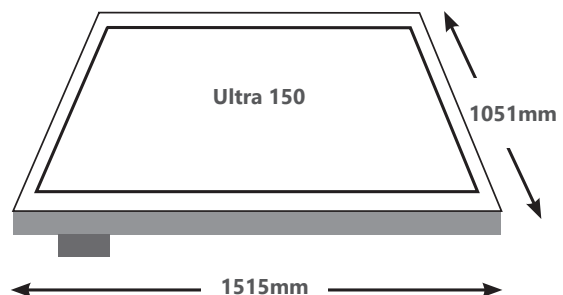
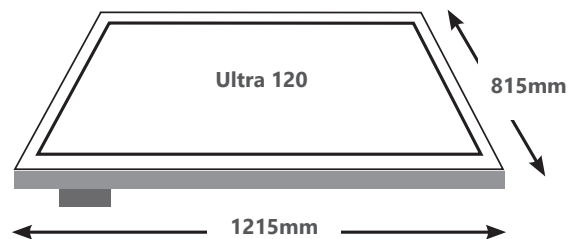

Crop mark detection

The Ultra V is also equipped with a camera for crop mark detection. This device is combined with operational software for ease of use and accuracy.

Valiani Ultra 120 | 150

The Packaging Tool set, consists of one head with 9 wheels of various geometry, these have been developed for the packaging market or for those who need to die cut flat board, flute board and polypropylene. This tools enables you to create boxes, folders, mock-ups and any other job that needs creasing or serrated cuts.



Interchangeable cutting heads

The Valiani Ultra V uses an array of Interchangeable cutting heads for its entire line of computerized cutters. These heads are retained and positioned to the cutting head assembly by means of several small, yet powerful magnets, which make locking fasteners and hardware unnecessary. A specialised wedge-fork tool is supplied that makes removal of each head easy, safe and fast in under 15 seconds. Each tool head is colour-coded and numbered to help simplify recognition at a glance.

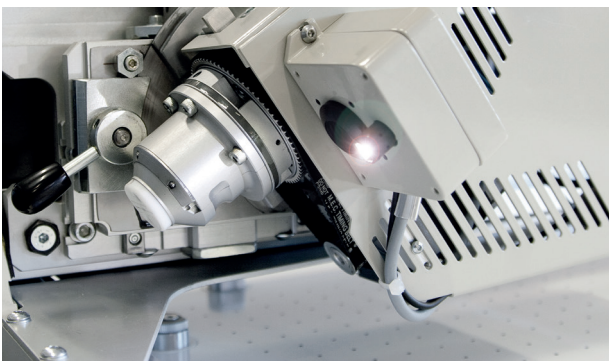

Ultra 120

Working area	1215 x 815mm
Width	1700mm
Depth	1200mm
Height	1100mm
Weight	250kg
Max Speed	365mm/sec
Main Supply	SP / 110V60Hz/10S, 220V/50Hz/10A
Pneumatics	6 Bar/90 PSI
Connectivity	USB
Data Buffer	External PC (Not included)
Tool Change	Manual
Media Holding System	Pneumatic

Ultra 150

Working area	1515 x 1051mm
Width	2010mm
Depth	1400mm
Height	1100mm
Weight	250kg
Max Speed	365mm /sec
Main Supply	SP / 110V60Hz/10S, 220V/50Hz/10A
Pneumatics	6 Bar/90 PSI
Connectivity	USB
Data Buffer	External PC (Not included)
Tool Change	Manual
Media Holding System	Pneumatic

- Blue 45° Bevel Cut (rear)
- Red 45° Bevel Cut (front)
- Yellow 90° Straight Cut (multi material)
- Purple Debossing
- White 90° Straight Cut
- Green 40° Bevel Cut (front)
- Grey 90° Straight Cut

Omnia, the new flat bed cutter with automatic feeder. The efficient solution for high volume cutting



Omnia

Valiani Omnia

The Valiani Omnia has been designed to automatically feed and cut material up to 600 x 800mm (B2) without the need for an operator to load and unload the sheets.

Key Features

- Continuous sheet media loading and processing
- High capacity feeder
- Perfect cutting and creasing on any media
- Equipped with vacuum table
- Cutting up to 12mm with the oscillating tool
- Uninterrupted workflow
- Camera and software to ensure precise alignment

The cutting arm is equipped with suction cups which lift the materials from the feeder and places them onto the conveyor belt. The conveyor moves the sheets in to the final position and the camera then identifies the crop marks that are printed on the sheet, the sheets are then cut and once the job is finished, each sheet moves into the collection tray.

Thicker materials such as FOREX or corrugated cardboard can also be loaded in to the feeder. The load capacity can manage up to 500 sheets (depending on the material thickness).

Valiani optional tools fit onto your tool holder or VersaTool to give it a dedicated function, for example oscillating knife, V cutting, kiss cutting and many more.

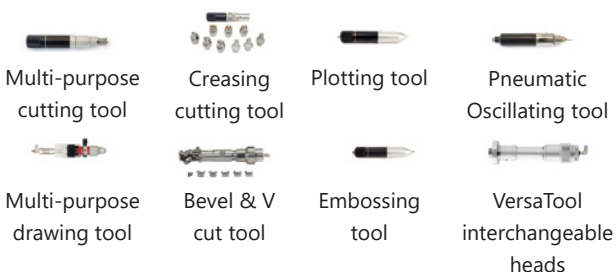

Interchangeable cutting heads

The Valiani machines use an array of Interchangeable cutting heads for its entire line of computerized cutters. These heads are retained and positioned to the cutting head assembly by means of several small, yet powerful magnets.

Omnia	
Maximum media size	600 x 800mm
Minimum media size	210 x 297mm
Feeder capacity	500 sheets (300gsm) - 200mm
Width without safety mat	1620mm (+2000mm for PC)
Depth without safety mat	3255mm
Height	1279mm
Weight	850kg
Max Speed	1350mm /sec
Main Supply	3 phase + PE 400V - 50Hz 13A - 5.2KVA
Pneumatics	8 Bar/115 PSI
Connectivity	USB
Data Buffer	External PC (Not included)
Tool Change	Manual
Media Holding System	Vacuum



Valiani

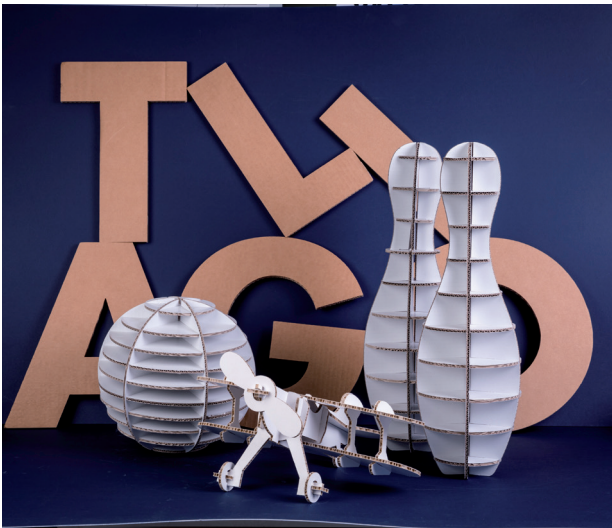

*Disclaimer As part of our continued product improvement plan, specifications and information published here are subject to change without notice. All specifications are dependent on application, type of stock, temperature, RH and print engine used. Specifications quoted were measured on uncoated and unprinted stock. E & OE.